

ASSEMBLY

- In factory
- On site

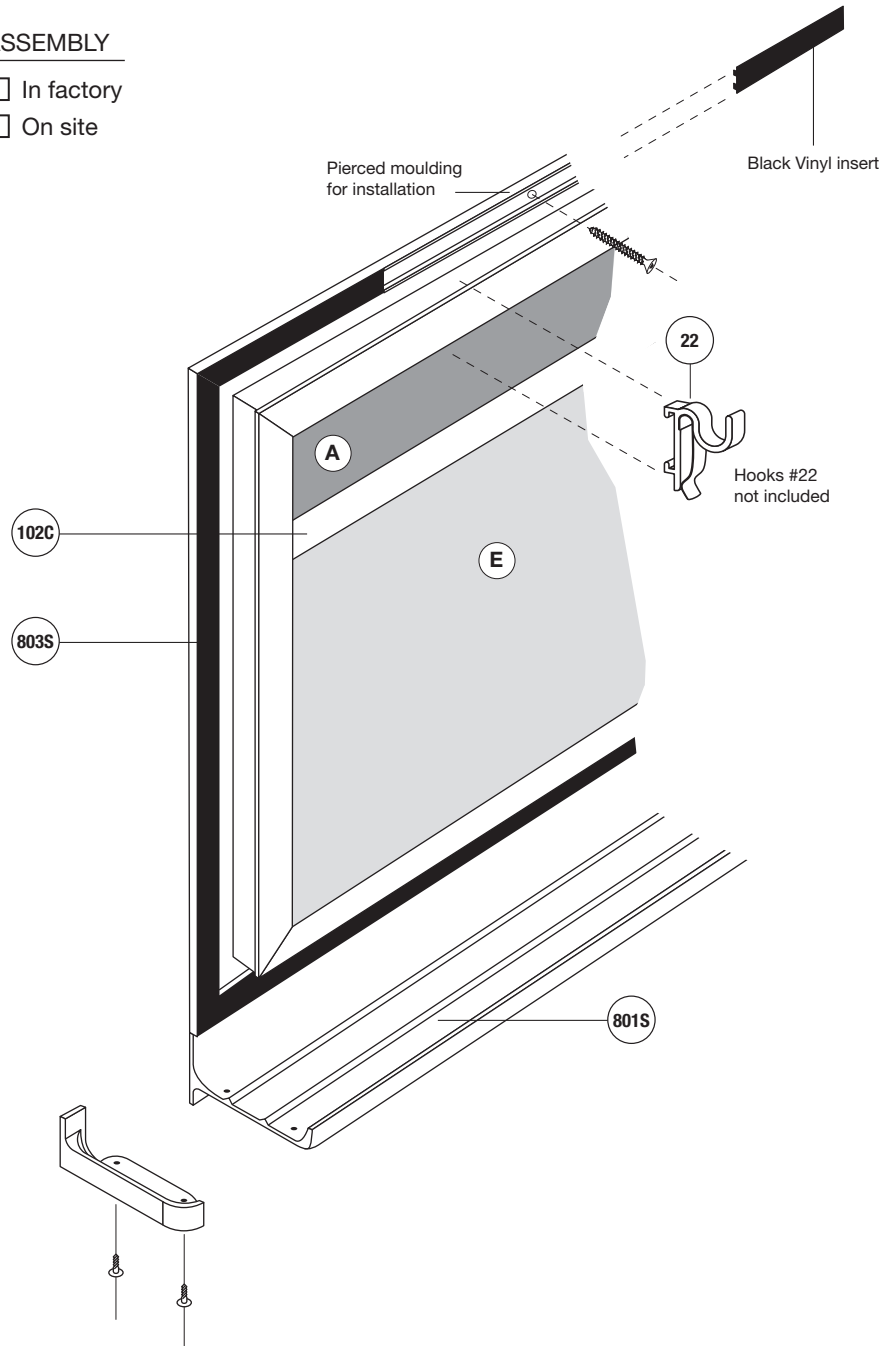

Dimensions

Type : _____

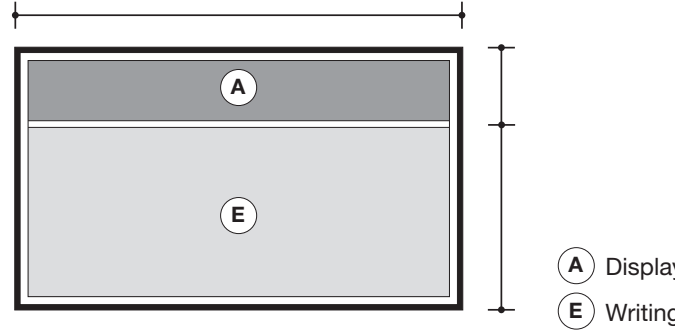

Total Height: _____ Total Width: _____
 (A) Width: _____ (E) Width: _____

Location:

Moulding

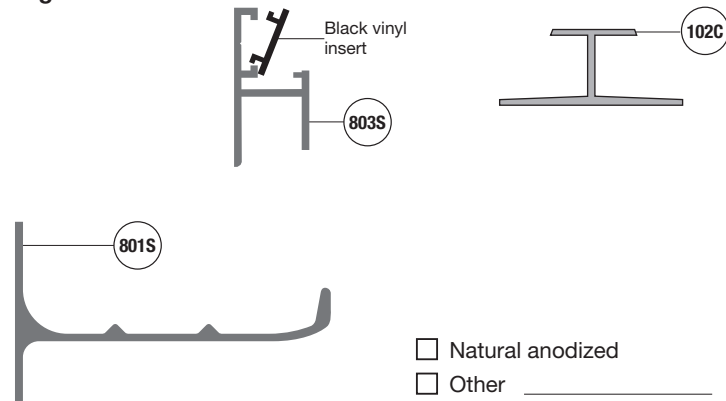

Mechanical joint

Surface display of more than 12 feet only.



8000

QUANTITY : _____

Writing surface (E)

- Lauzonite white green black grey
- Laminite white grey black
- Porcelain white green black

Display surface (A)

- Natural cork 1/4 1/8 1/32
- Colored cork: _____
- Fabric: _____
- Velcro: _____
- Other: _____

Hooks (not included)

- Type #22 Quantity: _____

Notes :

Contractor:

Architect:

Project:

Address: