

ASSEMBLY

- In factory
- On site

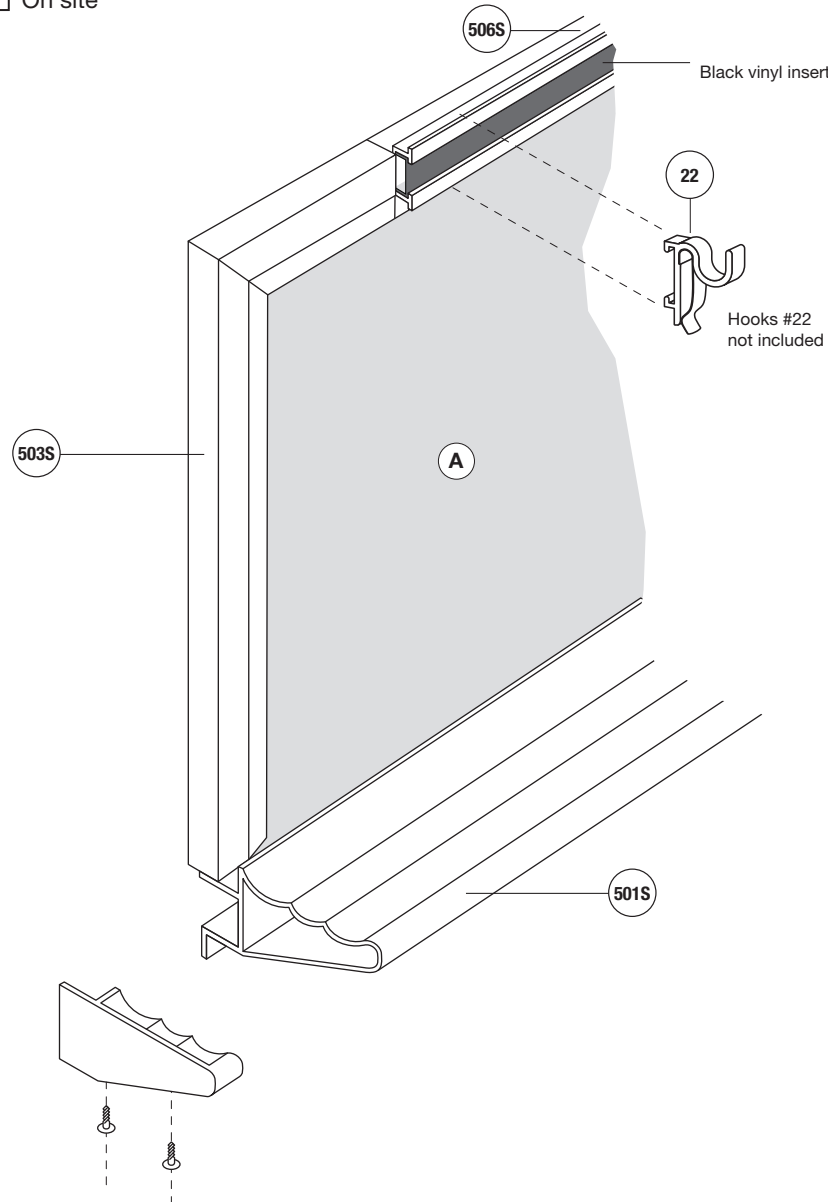

Dimensions

Type : _____

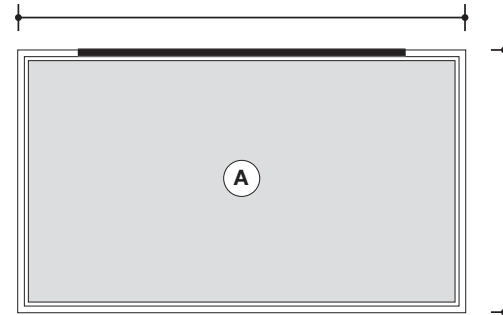

Height: _____ Width: _____

Location:

Moulding

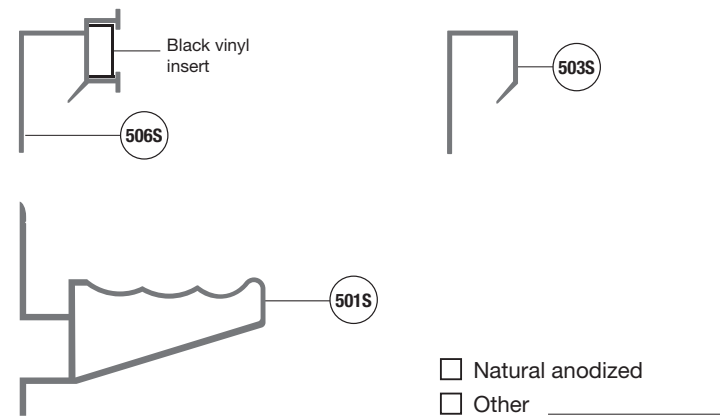

Mechanical joint

Surface display of more than 12 feet only.



5000

QUANTITY : _____

Surfaces A

- Lauzonite white green black grey
- Laminite white grey black
- Porcelain white green black
- Natural cork 1/4 1/8 1/32
- Colored cork: _____
- Fabric: _____
- Velcro: _____
- Other: _____

Hooks (not included)

- Type #22 Quantity: _____

Notes :

Contractor:

Architect:

Project:

Address: