

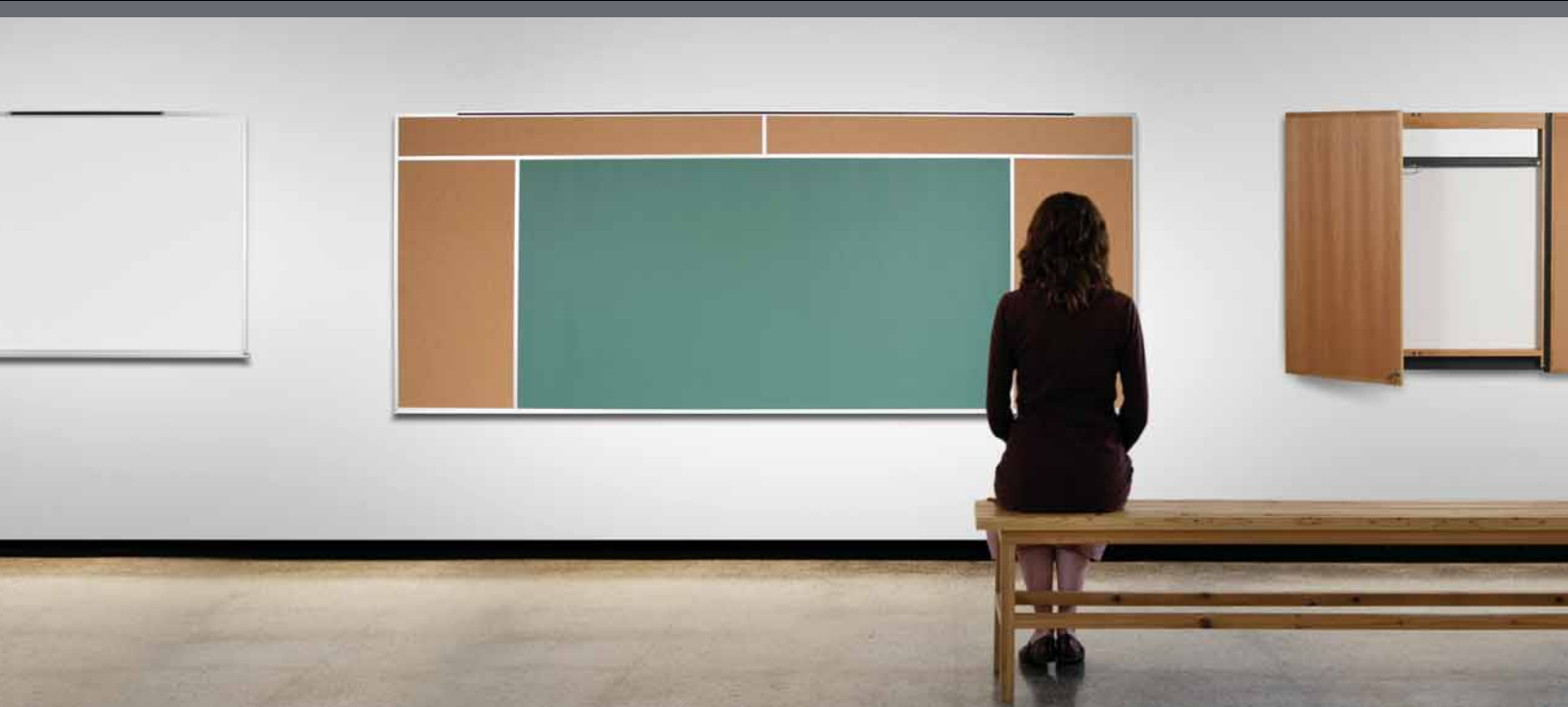

Canadian
BlackBoard
Company Ltd



An incomparable
selection
of boards

- school
- conference
- wood
- glass display cases
- accessories
- projection screens

TABLE OF CONTENTS

SURFACES

Writing	4
Display	5
Laminite	6

SCHOOL

2000	8
3000	9
5000	10
8000	11
Plastiportable	12-13
900 / 910	14
950	15
4000	16
555	17
Surfaces & combinations	18

WOOD

80 / 85 / 90	20
--------------------	----

CONFERENCE

710 / 711	22
712 / 713	23
714 / 715	24
716 / 717	25
718	26
Options	27
Finishes & installation	28

GLASS DISPLAY CASES

640 / 650 / 660	30
670 / 680	31

ECONOMICAL

40	33
70	34
571G / 572 / 610	35

CUSTOMIZED

Personalized	37
720	37

COMPLEMENTS

Projection screens	39
Directional network	40
Accessories	41
Mouldings	42-43



INTRODUCTION

MUCH MORE THAN BLACKBOARDS...

Since its foundation in 1932, our company has built a reputation for excellence in the manufacturing of top quality visual communication products with unequalled after-sales service. We distribute our products in Canada, the United States and in Europe.

The great diversity of our products enables us to serve a wide range of customers. Our products are used daily in schools, offices, government buildings, training centres, hospitals, hotels, restaurants and in the commercial and industrial world.

Our versatile and competent personnel adapt to our clients needs. Our sales team informs clients and helps them identify precisely which articles are best suited to their needs. Technical support is also available for architects, building contractors and designers.

We are proud to offer you the top quality standard and customized products that have forged our reputation. Each product is created and manufactured to meet our customer's individual specifications. Choosing a CBBC product ensures you of impeccable quality from a well-established and experienced company.

THE WARRANTY

The Canadian Blackboard Company Ltd offers a 12 month warranty, starting on the delivery date, against any manufacturing or installation defects on all products with the exception of economic boards and Duolox surfaces. Also, product use warranties varying from 3 months to 50 years are offered on chalkboard or marker surfaces (see page 4). To prolong the use of your Blackboard product, we provide the maintenance method specific to your board's surface. You will find it on an upper corner of your board.



surfaces

lauzonite
laminite
porcelain
dulox
natural cork
coloured cork
fabric, plain felt and velcro

surfaces

LAUZONITE

Lauzonite, a high-performance surface, is composed of a steel sheet (0.4 mm) coated with 3 layers of resin with carborundum and baked at a high temperature. Result: a durable, easy-to-clean surface that ensures full chalk lines and anti-glare visibility. 50-year (green, grey or black) or 5 year (white) warranty*

Sizes

4' X 6' 4' X 10'
4' X 8' 4' X 12'

Thickness

1/2"
1/4"
1/8"

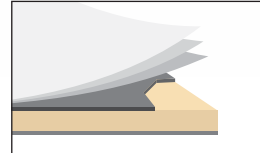

COLOURS ▶    

LAMINITE

Laminated polyester film on steel sheet (0.4 mm). Erases very easily. Formability with perfect adherence of film on steel. 5-year warranty*

Sizes

4' X 6' 4' X 10'
4' X 8' 4' X 12'

Thickness

1/2"
1/4"
1/8"

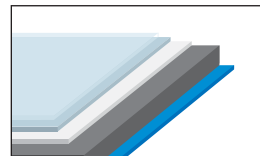

COLOURS ▶  

PORCELAIN

It's primary quality: hardness, making it almost impossible to scratch. This surface is composed of 2 layers of vitreous enamel baked on a steel sheet (0.4 mm) at a very high temperature. 50-year warranty*.

Sizes

4' X 6' 4' X 10' 4' X 16'
4' X 8' 4' X 12'

Thickness

1/2"
1/4"
1/8"

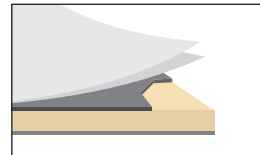

COLOURS ▶   

* 5' height available (white only).

DUOLOX

Economical surface composed of a dense fibre (Masonite) panel coated with two thin layers of paint. Caution: this surface is not intended for classroom use. For family or occasional use only. Thickness: 1/8". 3-month warranty*.

Sizes

4' X 6'
4' X 8'

Thickness

1/8"

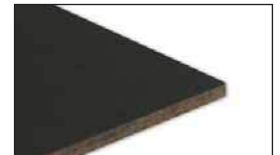
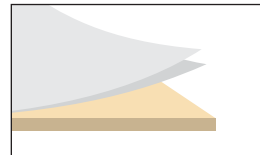

COLOURS ▶   

* Under normal use, using the appropriate chalk or marker and applying the specific cleaning methods as indicated on the label applied to the top corner of the board. The warranty is limited to peeling and cracking of the surface. For cleaning methods, consult our web site at www.cctn.com.



NATURAL CORK

Top quality fine grained natural cork is offered in three thicknesses:



1/4



1/8



1/32

Thickness	1/2" Laminate	Roller
1/4"	1/4" on 1/4"	80'
1/8"	1/8" on 3/8"	180'
1/32"	1/32" on 7/16"	328'



COLOURED CORK

Coloured cork: elastic linoleum surface material with jute backing for use with tacks. The surface is washable. Offered in a choice of 5 standard colours.



COLOURS

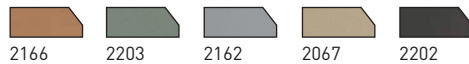

Thickness	1/2" Laminate	Roller
1/4"	1/4" on 1/4"	90'



FABRIC



VELCRO



PLAIN FELT



GROOVED FELT



Fabric, plain felt and Velcro are offered on 1/2" fiberboard.

Fabric: Selected from the Guilford of Maine or Vicor Innovatex charts.

Velcro and felt: Offered in black, other colours depending on availability.

COLOURS



surfaces

LAMINITE

Low Carbon steel for formability, Continuous Hot Dip Galvanized (CS) per ASTM A653. The steel sheet is first pre-coated with a Polyester resin based paint, then co-laminated with a "PET" (PolyEsTer) film; finally, a back coat with primer is finally applied to the other side to promote adhesion.

PRODUCT CHARACTERISTICS:

- PET film colaminated onto magnetic steel sheet in 2 possible finishes: smooth or embossed "orange peel".
- Colours: white or metallic. Other colours available by special order only.
- Specular luminance Gloss (60o) is optimized above 90 degrees.

EXCELLENT INTRINSIC CHARACTERISTICS:

- Unique composite finish
- Exceptional durability
- Perfect adherence of film on metal
- Corrosion resistance
- Exceeds all industry standards.

COLOURS



Easy-to-erase surface

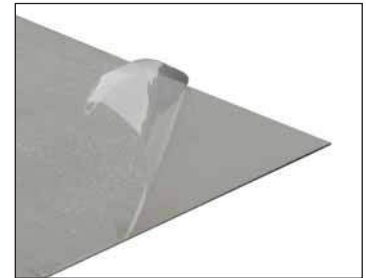

Resistant protective film

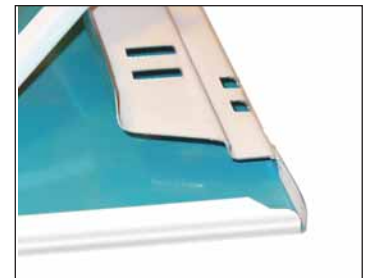

Post-formable

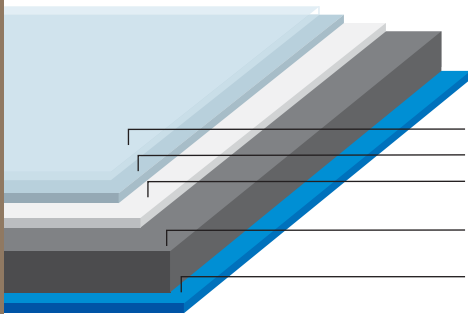

- Protective Film
- PET Film
- Base paint coat
(White or Metallic Grey)
- Base material (Steel)
- Back paint coat



school

2000
3000 / 5000
8000 / 4000
plastiportable
900 / 910 / 950
555

series



school

A DISTINGUISHED LOOK

The most popular, our best classic of the school series, with its delicate moulding firmly framing the chalkboard. Anodized aluminum moulding.



Sizes

- 2' X 3' 4' X 10'
- 2' X 4' 4' X 12'
- 3' X 4' 4' X 16' (in 2 sections)
- 4' X 4'
- 4' X 5' Other combinations
- 4' X 6' and / or sizes available on
- 4' X 8' request.

201



206



203

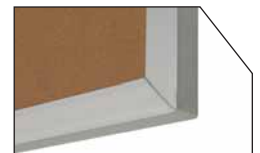

Characteristics and choice of surfaces on page 18.

Permanent on-site installation

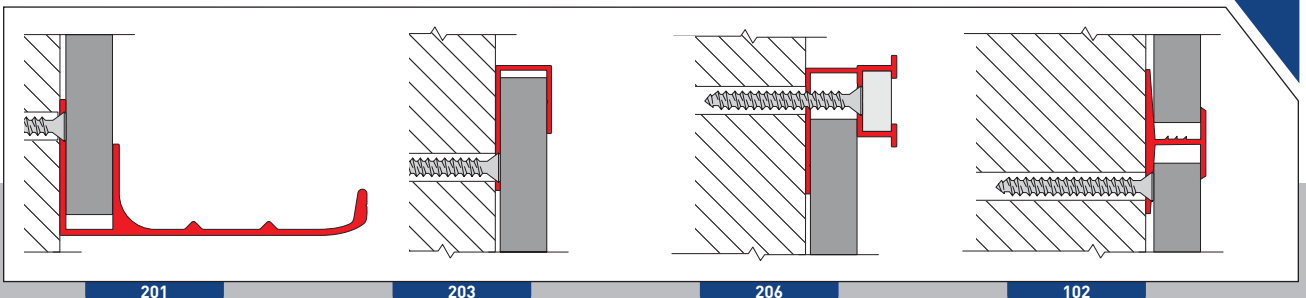

201

203

206

102



EXCEPTIONAL STURDINESS

This series combines the sturdiness of its thick moulding with the simplicity and solidness of its installation. Anodized aluminum moulding.



Sizes	
2' X 3'	4' X 10'
2' X 4'	4' X 12'
3' X 4'	4' X 16' (in 2 sections)
4' X 4'	
4' X 5'	Other combinations
4' X 6'	and / or sizes available on
4' X 8'	request.

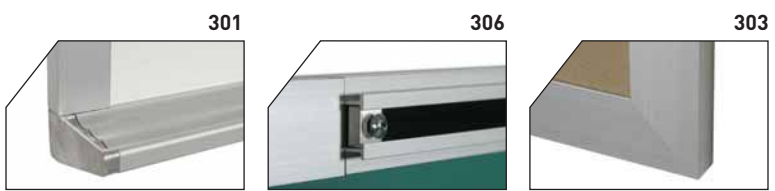

Permanent on-site installation

Characteristics and choice of surfaces on page 18.

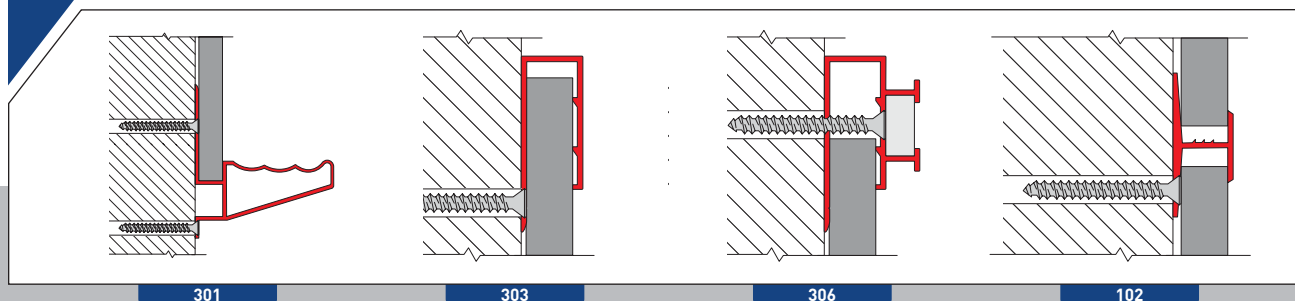



school

STYLE AND ELEGANCE

Series 5000 is by far the most popular in conference and training rooms. Its narrow, bevelled moulding gives it a clean finish and a highly appreciated stylish form. Anodized aluminum moulding.



Sizes

- 2' X 3' 4' X 10'
- 2' X 4' 4' X 12'
- 3' X 4' 4' X 16' (in 2 sections)
- 4' X 4'
- 4' X 5' Other combinations
- 4' X 6' and / or sizes available on
- 4' X 8' request.

503



506



501



Characteristics and choice of surfaces on page 18.

Permanent on-site installation

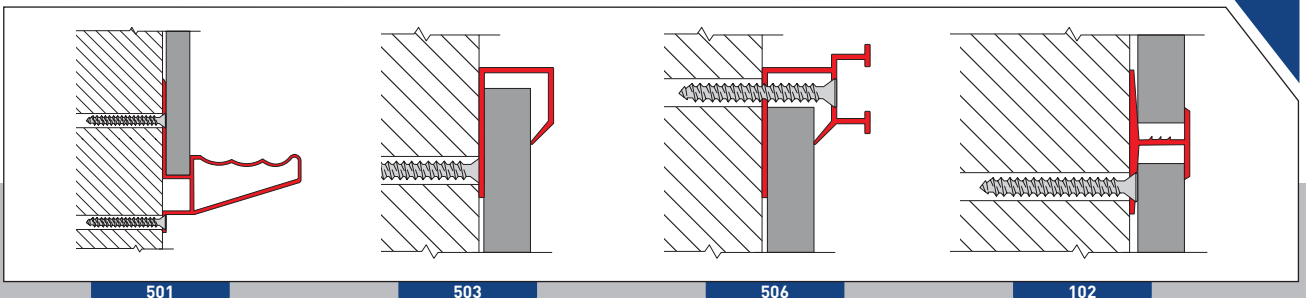

501

503

506

102



DOUBLE SURFACE

Series 8000 can be distinguished by its black vinyl decorative band that conceals the anchor screws. What's more, its moulding profile was designed to incorporate a horizontal sliding panel (series 8500)

on nylon wheels, for classrooms requiring a larger writing surface. Anodized aluminum moulding.

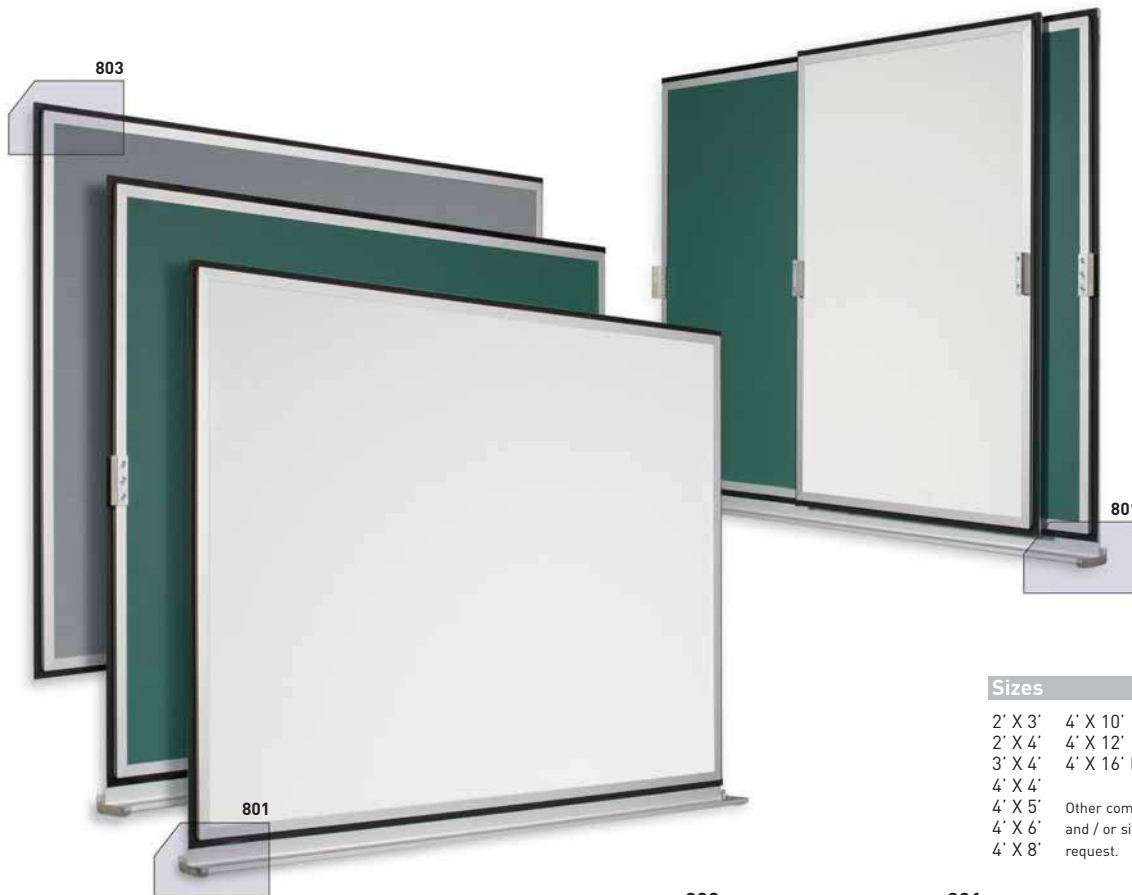

Sizes	
2' X 3'	4' X 10'
2' X 4'	4' X 12'
3' X 4'	4' X 16' (in 2 sections)
4' X 4'	
4' X 5'	Other combinations
4' X 6'	and / or sizes available on
4' X 8'	request.



Permanent on-site installation

Characteristics and choice of surfaces on page 18.

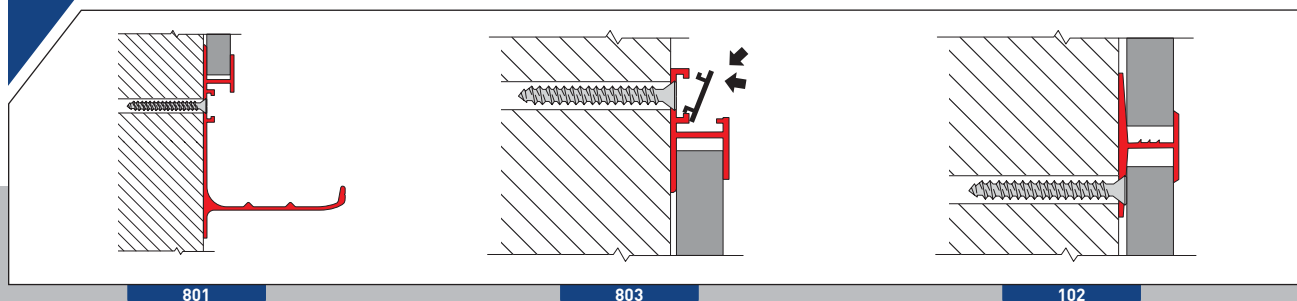

801

803

102

school

THE PORTABLE WRITING BOARD

Portable plastic dry-erase marker board. Facilitates classroom allocation. Available in 5 models (see illustrations), each with a white writing surface and black lines.

It also rolls up easily after use for safe storage in its individual packaging. The plastiportable adheres magnetically to all painted steel or porcelain surfaces. Then it's ready to be used!

ABS plastic sheet, 0.030" thick. Specially treated in our workshops to prepare it for the application of writing film. Brush and 2 markers included.

The very lightweight plastiportable (total weight of 7 lbs) tucks easily under your arm. Simply unroll it from its individual protective tube and ready to lay out flat before hanging it wherever you like.



Easy to unroll and roll up again into its individual protective tube.

The Cartesian

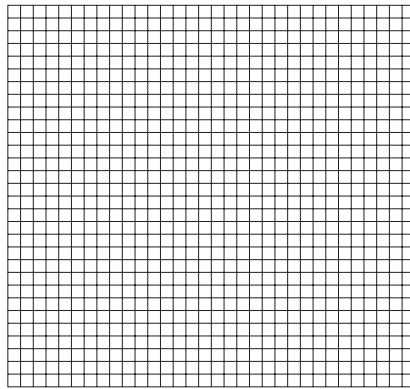

44" X 48"

1 1/2" 4900-A1

2" 4900-A2



Tucks easily under your arm.

The All-White

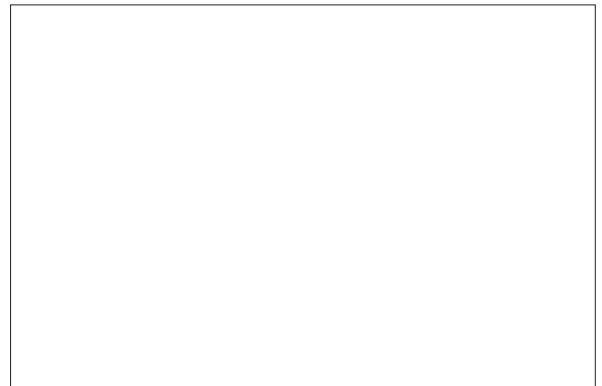

44" X 64"

4900-B



Between the Lines

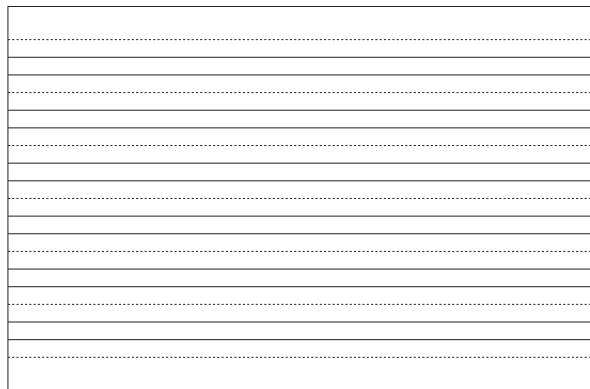

44" X 64"

4900-C

The four-staff Musician board



44" X 64"

4900-D

The Cartesian

(with red X and Y axes)

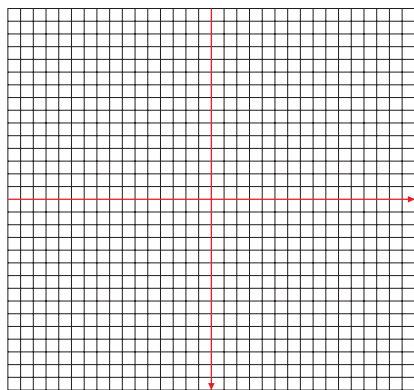

44" X 48"

1 1/2" 4900-E

Adheres magnetically to all painted steel or porcelain surfaces.



2 black markers

Includes these two items

— 1 brush



school



VERTICAL SLIDERS

This is one of our specialized models, just the thing for amphitheatres and laboratories. It includes one fixed panel and one (series 900) or two (series 910) sliding panels. The counterweight mechanism consists of ball-bearing pulleys and a steel cable. Its anodized aluminum jamb extrusions are solid and easy to maintain.

sists of ball-bearing pulleys and a steel cable. Its anodized aluminum jamb extrusions are solid and easy to maintain.

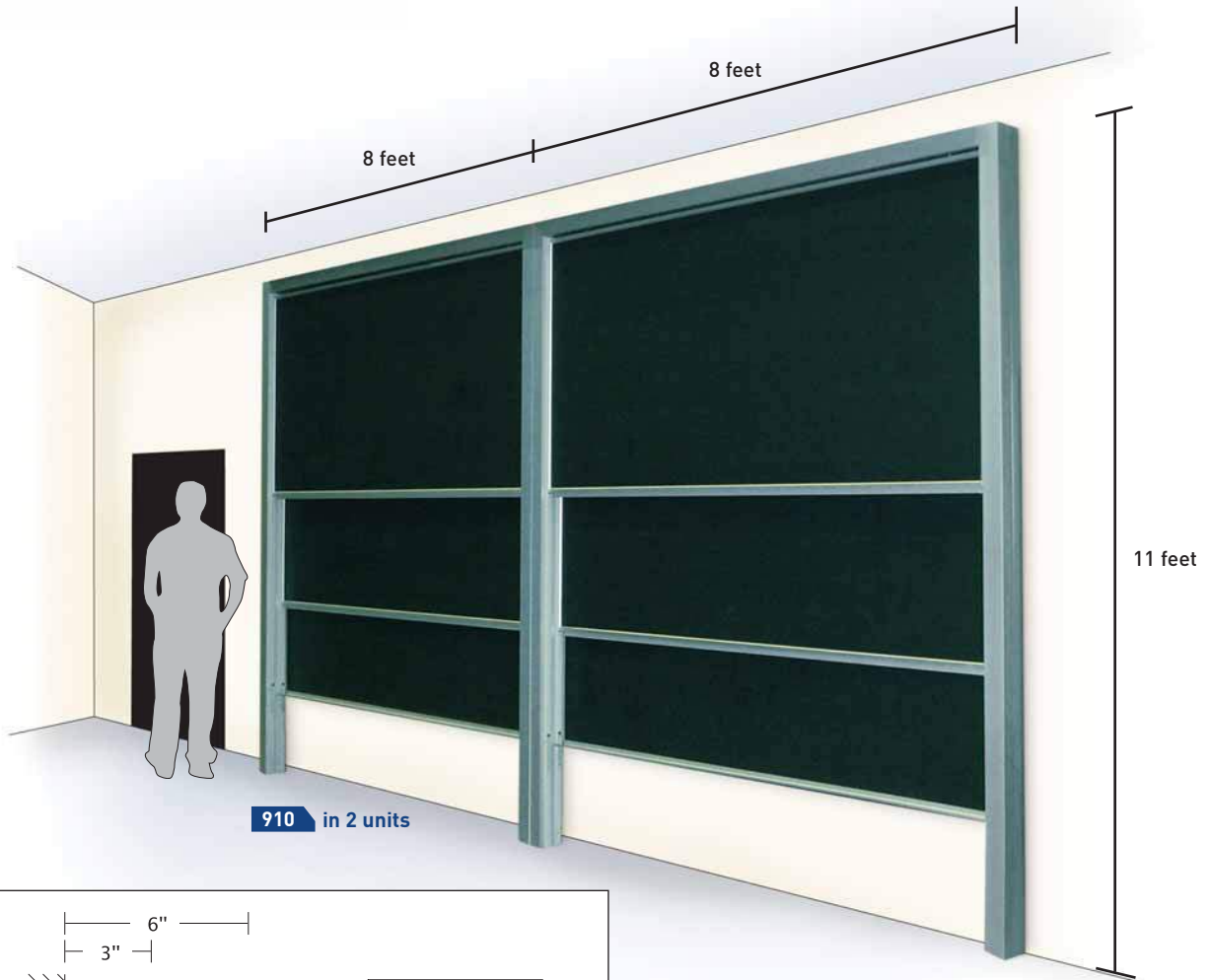

910 in 2 units

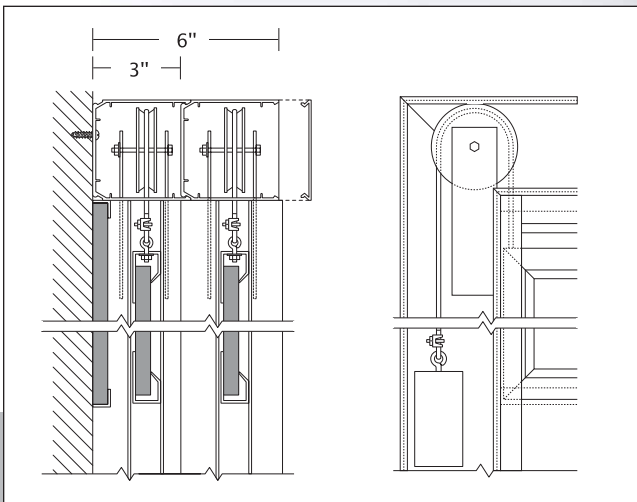

Side view of mechanism

Front view of mechanism

Sizes

- 4' X 6' Other combinations
- 4' X 8' and / or sizes available
- 4' X 10' on request.

Characteristics and choice of surfaces on page 18.



HORIZONTAL SLIDERS

Series 950 is the solution for maximizing writing and/or display surfaces. With its 3" aluminum frame, it also includes a slide system at its base and a nylon ball-bearing caster system at the top of the frame. The writing surfaces can be as diversified as

the imagination and basic choices allow. The sliding system can be doubled (Series 960), tripled (Series 970) or more, depending on your needs. Chalk rail included.



A

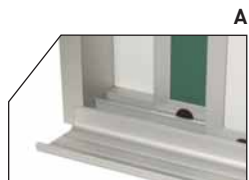

A

- Sizes**
- 4' X 6' 4' X 20'
 - 4' X 8' 4' X 24'
 - 4' X 10' Other combinations
 - 4' X 12' and / or sizes available
 - 4' X 16' on request.

Characteristics and choice of surfaces on page 18.

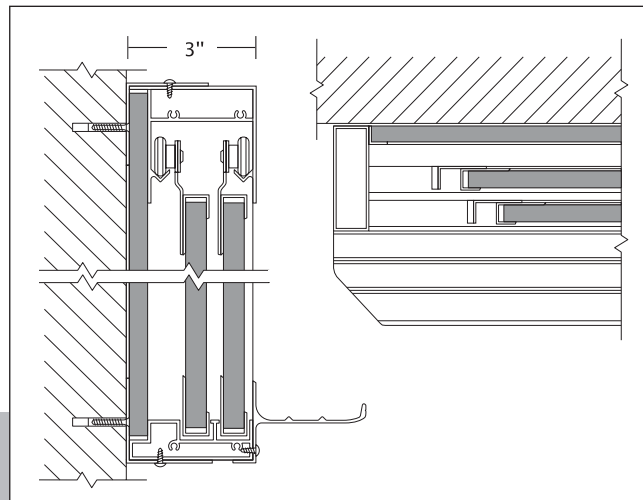

Side view of mechanism

Top view of chalk rail



school

A MULTITUDE OF CHOICES

Series 4000 boards are characterized by their display surfaces. Natural aluminum moulding.



443

4200 Fabric

4100 Plain felt

4300 Velcro

443

4500 Natural cork 1/8" on 3/8"

Sizes

- 18" X 24" 48" X 96"
- 24" X 36"
- 36" X 48" Other combinations
- 48" X 48" and / or sizes available
- 48" X 72" on request.

443



443



Characteristics and choice of surfaces on page 18.



MOBILITY AND DUALITY

Series 555 provides a double surface as well as mobility owing to its caster system. Its tubular steel mounting gives it lasting sturdiness. A pivoting mechanism allows you to turn the board over rapidly and position it at the desired angle. This board can

be covered with any of the available surfaces (porcelain, lauzonite, laminate, cork, fabric and Velcro).

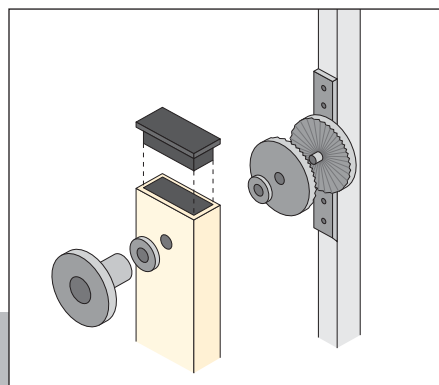
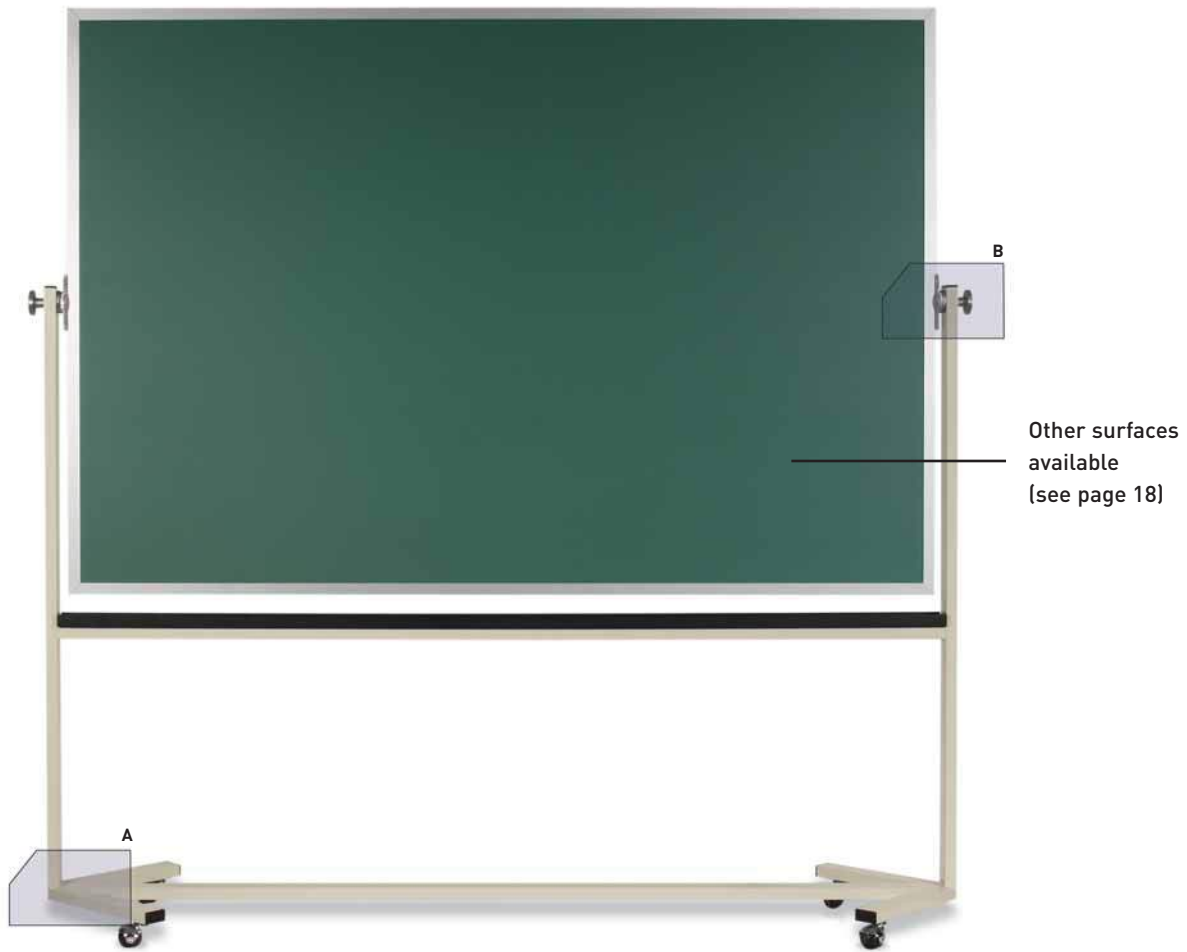

Sizes

- 3' X 4' 4' X 6'
- 4' X 4' 4' X 8'
- 4' X 5'

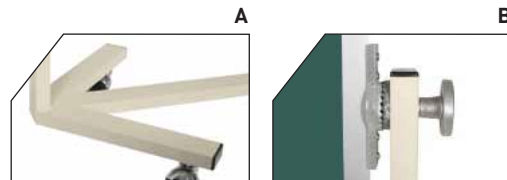

















Characteristics and choice of surfaces on page 18.



school

SURFACES

You can create your choice of combinations amongst the surfaces listed below for all of the series.

- Lauzonite    
- Laminite  
- Pocelain (Tremcelite)   
- Coloured cork     
- Pernatan cork (Natural) 1/8 - 1/4 and 1/32 
- Fabric  Other colours on request
- Felt - Velcro  Other colours on request

COMBINATIONS

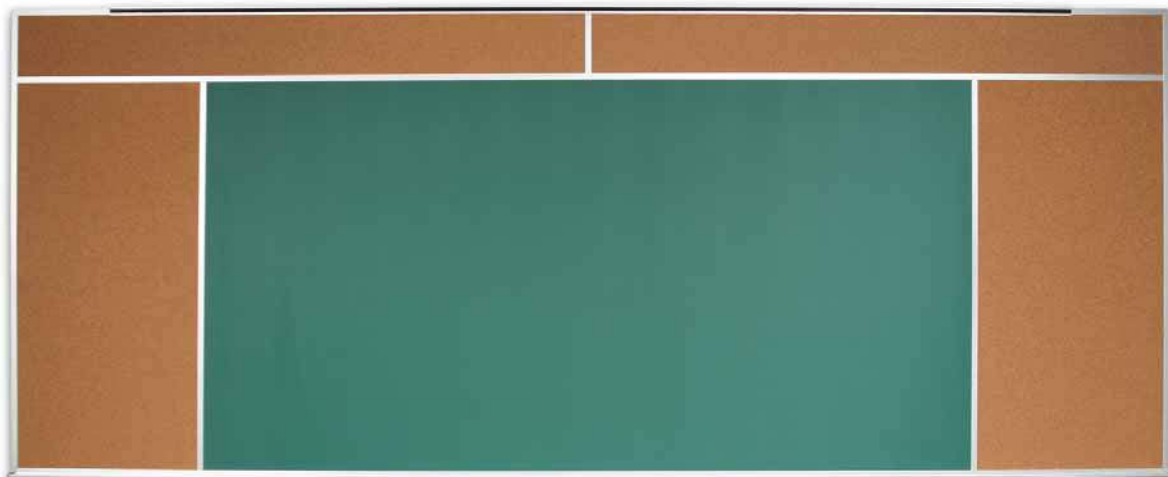

The white section corresponds to the writing surface, and the shaded section to the display surface.

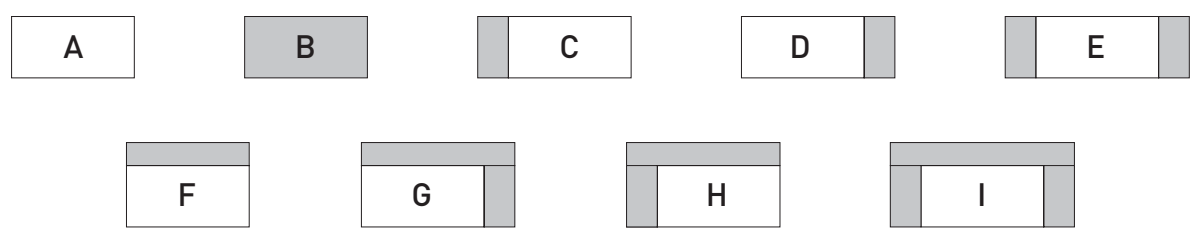



wood

80 / 85 / 90

series

wood

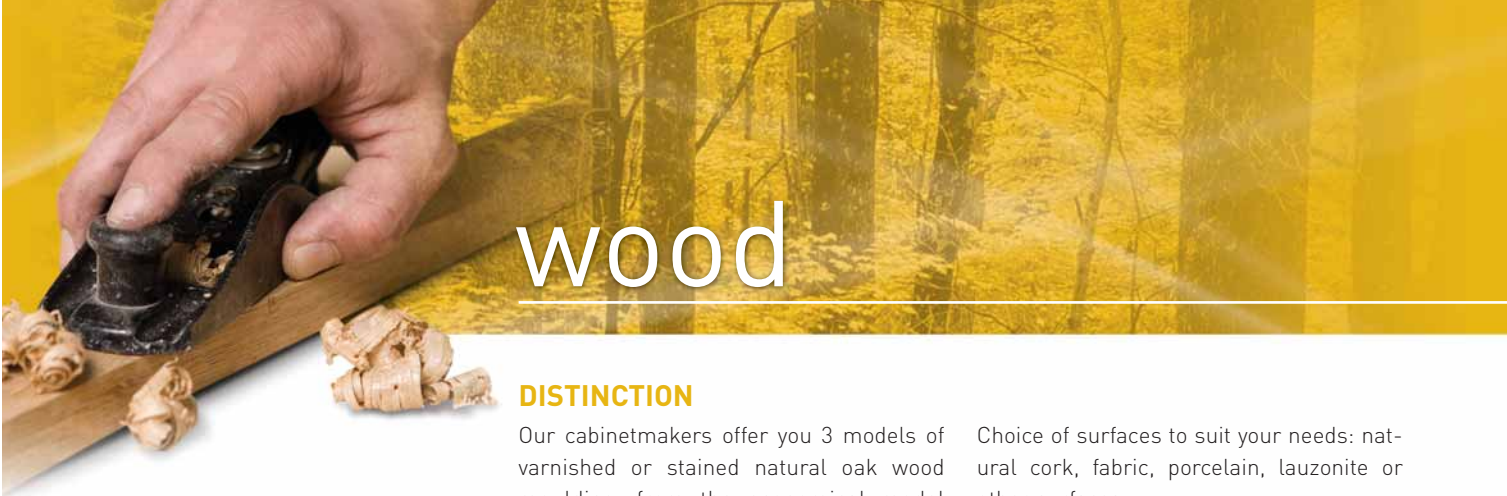

DISTINCTION

Our cabinetmakers offer you 3 models of varnished or stained natural oak wood moulding, from the economical model (series 80) to the robust series 90 model. Chalkrail are optional on all three models.

Choice of surfaces to suit your needs: natural cork, fabric, porcelain, lauzonite or other surfaces.



Chalkrail series 85-90



Chalkrail series 80

Sizes	
2' X 3'	4' X 5'
2' X 4'	4' X 6'
3' X 4'	4' X 8'
4' X 4'	Other sizes on request.



Characteristics and choice of surfaces on page 18.



conference

710 / 711
712 / 713
714 / 715
716 / 717
718

series



conference

LUXURIOUS

Complete your conference room décor with a 710 or 711 model communication board. The result of industrial design research, the ingenious closing mechanism functions with horizontal strap hinges. These stylized, discrete hinges are made of solid alu-

minum. Practical, the upper moulding is designed to hold a pull down projection screen and a flip chart. A tray on the lower edge of the board holds and conceals erasers and markers.

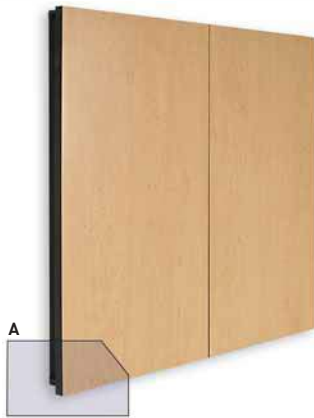

711
Laminated
finish



710
Wood veneer
finish



Sizes

- 42" X 48"
- 42" X 60"
- 42" X 72"

Characteristics and available options on pages 27 and 28.





SOLID

Add a touch of elegance to your conference room with a 712 or 713 model communication board. These top of the line boards are built in solid wood and are varnished in one of the 5 basic colours available. On request and with the help of a sample, we can give your board the same finish as your conference room furniture. These boards are fitted with piano hinges, an optional integrated projection screen and a marker tray.

High quality white porcelain steel covers the central panel. The boards have 2 side doors equipped with display panels, the left one with a flip chart.



Sizes

- 48" X 48"
- 48" X 60"
- 48" X 72"

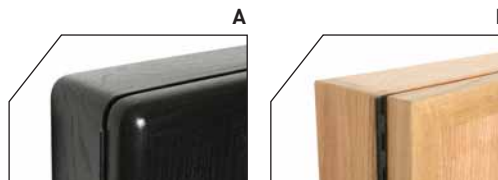

Characteristics and available options on pages 27 and 28.

conference



ECONOMICAL

Equip your conference room with a Series 714 or 715 communication board. Offered at an affordable price, these boards can be distinguished by their slim profile: 1 1/2" when closed. The optional marker tray on the outside lower edge remains visible

when the doors are closed. These boards are fitted with piano hinges and anodized natural aluminum mouldings. Both pleasing to the eye, model 714 offers a wood veneer exterior finish, whereas model 715 has a laminated finish. Top quality white porcelain-on-steel covers the central panel. These boards have two doors with a flip chart on the left one. The doors can be covered with natural cork, coloured cork, fabric or a white magnetic surface.



Sizes

- 48" X 30" (1 door)
- 36" X 48"
- 48" X 48"
- 48" X 60"
- 48" X 72"

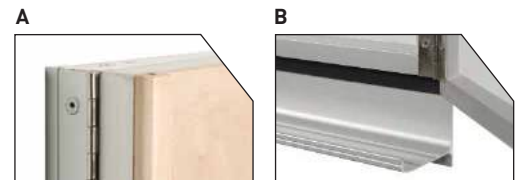

Characteristics and available options on pages 27 and 28.

POPULAR

These attractive boards are an excellent value, and are the most popular with our customers. Made of high quality melamine, they fit in perfectly with your conference room decor. The 717 model includes a built-in projection screen. These boards come in a range of five exterior finishes: light oak, black oak, maple, mahogany and cherry. On request, and for an additional supplement, we can give the board your

choice of finish. These boards are fitted with piano hinges. Top quality white porcelain-on-steel covers the central panel. The boards have 2 side doors each equipped with display panels, the left one with a flip chart.



717
With screen
Thickness 4"



716
Without screen
Thickness 3"

Sizes

- 45" X 48"
- 45" X 60"

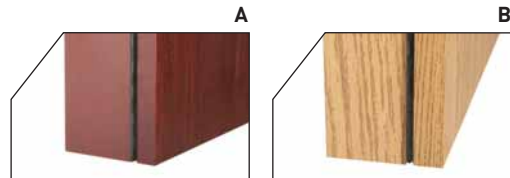

Characteristics and available options on pages 27 and 28.



conference

COMPLETE

To meet our customers' needs, we have combined the characteristics of models 714 and 716 to create model 718. A 2 1/4" deep black melamine box conceals the marker tray inside the board. The central panel is comprised of white porcelain-on-steel. These boards have two doors covered with

your choice of surface: natural cork, coloured cork, fabric, or white porcelain-on-steel. The left door has a flip chart. Both doors have a laminated exterior finish.



Sizes

- 45" X 48"
- 45" X 60"



Characteristics and available options on pages 27 and 28.



COMPARATIVE CHART

Conference board options chart showing the different standard options for each conference board.

Options available depending on the model

	710	711	712	713	714	715	716	717	718
WHITE STEEL BACK PANEL	✓	✓	✓	✓	✓	✓	✓	✓	✓
RIGHT DOOR: NATURAL CORK	✓	✓	✓	✓	✓	✓	✓	✓	✓
LEFT DOOR: NATURAL CORK + FLIP CHART	✓	✓	✓	✓	✓	✓	✓	✓	✓
BLACK ANODIZED MOULDING	✓	✓	✗	✗	●	●	✗	✗	✗
NATURAL ANODIZED ALUMINUM MOULDING	✓	✓	✗	✗	✓	✓	✗	✗	✗
WOOD FINISH	✓	✗	✓	✓	✓	✗	✗	✗	✗
LAMINATED FINISH	✗	✓	✗	✗	✗	✓	✗	✗	✓
MELAMINE FINISH	✗	✗	✗	✗	✗	✗	✓	✓	✗
MARKER TRAY AND BRUSHES	✓	✓	✓	✓	●	●	✓	✓	✓
MARKERS (4) AND BRUSH	✓	✓	✓	✓	✓	✓	✓	✓	✓

Additional options with a supplement (\$)

WHITE PORCELAIN SURFACE	●	●	●	●	●	●	●	●	●
1) WHITE DOOR	●	●	✗	✗	●	●	✗	✗	●
2) WHITE DOOR + FLIP CHART	●	●	✗	✗	●	●	✗	✗	●
3) COLOURED CORK DOOR	●	●	✗	✗	●	●	✗	✗	●
4) COLOURED CORK DOOR + FLIP CHART	●	●	✗	✗	●	●	✗	✗	●
5) FABRIC-COVERED DOOR	●	●	●	●	●	●	✗	✗	●
6) FABRIC-COVERED DOOR + FLIP CHART	●	●	●	●	●	●	✗	✗	●
PROJECTION SCREEN	●	●	●	●	✗	✗	✗	✓	●
LOCK	✗	✗	●	●	✗	✗	●	●	✗
STAINED WOOD FINISH	●	✗	●	●	●	✗	✗	✗	✗
LIGHTING SYSTEM	●	●	●	●	●	●	●	●	●
EXTRA FLIP CHARTS	●	●	●	●	●	●	●	●	●
EXTRA MARKERS AND BRUSHES	●	●	●	●	●	●	●	●	●

- ✓ STANDARD
- OPTION
- ✗ NOT AVAILABLE



conference



LAMINATED AND MELAMINE FINISHES



VENEER FINISHES

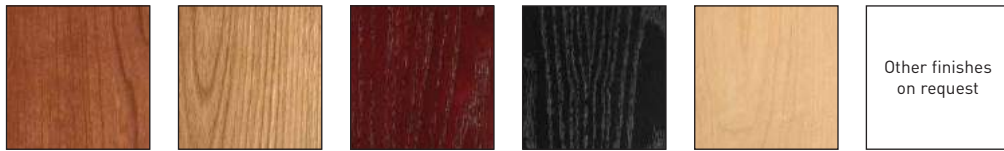

CHERRY

LIGHT OAK

MAHOGANY

BLACK OAK

MAPLE

DISPLAY SURFACES



Natural cork

Coloured cork

Fabric

WRITING SURFACES

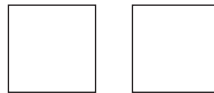

Porcelain

Lauzonite

ALUMINUM MOULDING



Black anodized

Natural anodized

Sizes

710 / 711	712 / 713	714 / 715	716 / 717 / 718
42" X 48"	48" X 48"	48" X 30"	45" X 48"
42" X 60"	48" X 60"	36" X 48"	45" X 60"
42" X 72"	48" X 72"	48" X 48"	
		48" X 60"	
		48" X 72"	

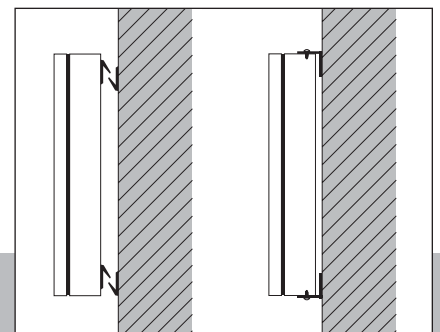

Installation system



glass display cases

640 / 650 / 660
670 / 680

series

glass display cases



DISPLAY CASE

Display case with locking glass door on piano hinges. Natural anodized aluminum, black or solid oak moulding. Back panel in cork, fabric, Velcro or other surfaces.



640

Varnished oak

650



2 separate units

650

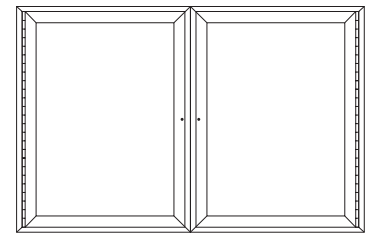

3 separate units

660

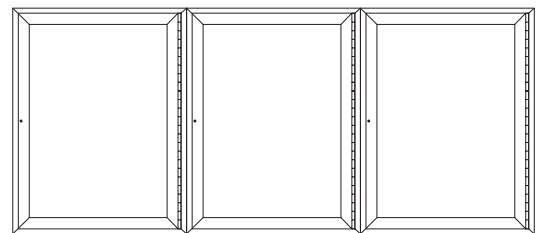

Aluminum

Wood



Natural anodized



Black anodized



Solid oak

Other finishes on request

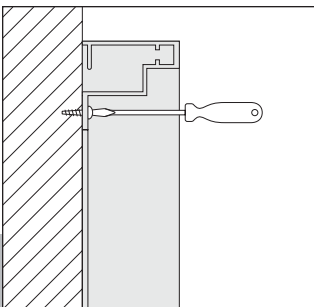

Remove the bottom pannel and screw

Sizes

- 24" X 18" 48" X 36"
- 36" X 24" 48" X 48"
- 36" X 36" Other sizes on request.



Characteristics and choice of surfaces on page 18.

MODEL 670

Display case with sliding glass doors and lock. Back panel to suit your needs in cork, fabric, Velcro or other surfaces. 3" thick frame with natural anodized aluminum, black or solid oak moulding. Slide mechanism on metal rails and nylon rollers.

MODEL 680

Display case comprising two adjustable glass shelves with sliding glass doors and lock. Melamine or laminated frame in our available colours. Back panel in natural cork, fabric, Velcro or other surfaces. Depth: 6", 8" or 12"

Aluminum

670



tinted oak

670



680



Exterior finish

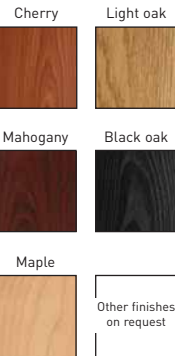

Aluminum

Wood

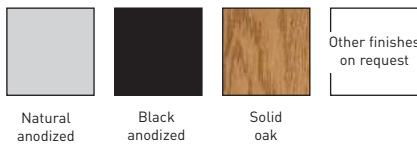

Sizes

- 24" X 36" 48" X 72"
- 36" X 48" 48" X 96"
- 48" X 48"
- 48" X 60" Other sizes on request.

670

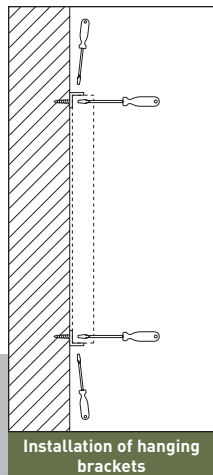

680

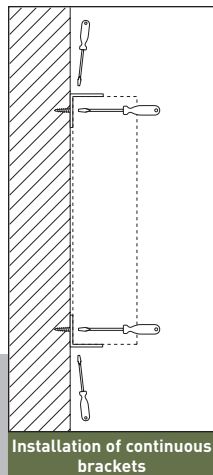

Characteristics and choice of surfaces on page 18.



economical

40
70
571G / 572 / 610

series

economical

SERIES 40

THE MOST ECONOMICAL

Economical series with natural aluminum moulding and a writing surface in lauzonite, porcelain or white, green or black Duolox. Display surface in natural cork.



Sizes

18" X 24" 48" X 72"
24" X 36" 48" X 96"
36" X 48"

Thickness

1/8" writing board
1/2" display board

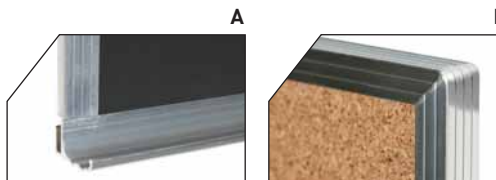

economical



economical

PLASTIC

Economical series with black plastic moulding and writing surface in lauzonite, porcelain and white, green or black Duolox. Display surface in natural cork.



Sizes

- 18" X 24"
- 24" X 36"
- 36" X 48"

Thickness

- 1/8" writing board
- 1/2" display board





MODEL 571G

Conference easel, white back panel with flip chart. Writing surface 24" x 36", height 72"

MODEL 610

Letter board with aluminum moulding. Used with removable letters. Back panel in grooved black felt. Other colours depending on availability.

Box of letters, numbers and punctuation in 1" roman style, 435-piece set. Board and letters sold separately.

571G



610



Sizes

- 24" X 18" 48" X 36"
 - 36" X 24" 48" X 48"
 - 36" X 36"
- Other combinations and / or sizes on request

572

MODEL 572

Small telescopic aluminum easel. For light boards measuring 36" x 48" or less.



customized

personalized
720

series

customized



PERSONALIZED

Control board, in/out boards, sales and production monitoring or statistical charting: whatever your visual communication needs, the Canadian Blackboard Company has a solution for you. We make boards to meet your specifications, in the size and material that suit your needs.

Lined or lettered boards, black or coloured, magnetic or not – we make them according to your plans. Our specialized team can even advise you to ensure you obtain a product perfectly adapted to its intended use.

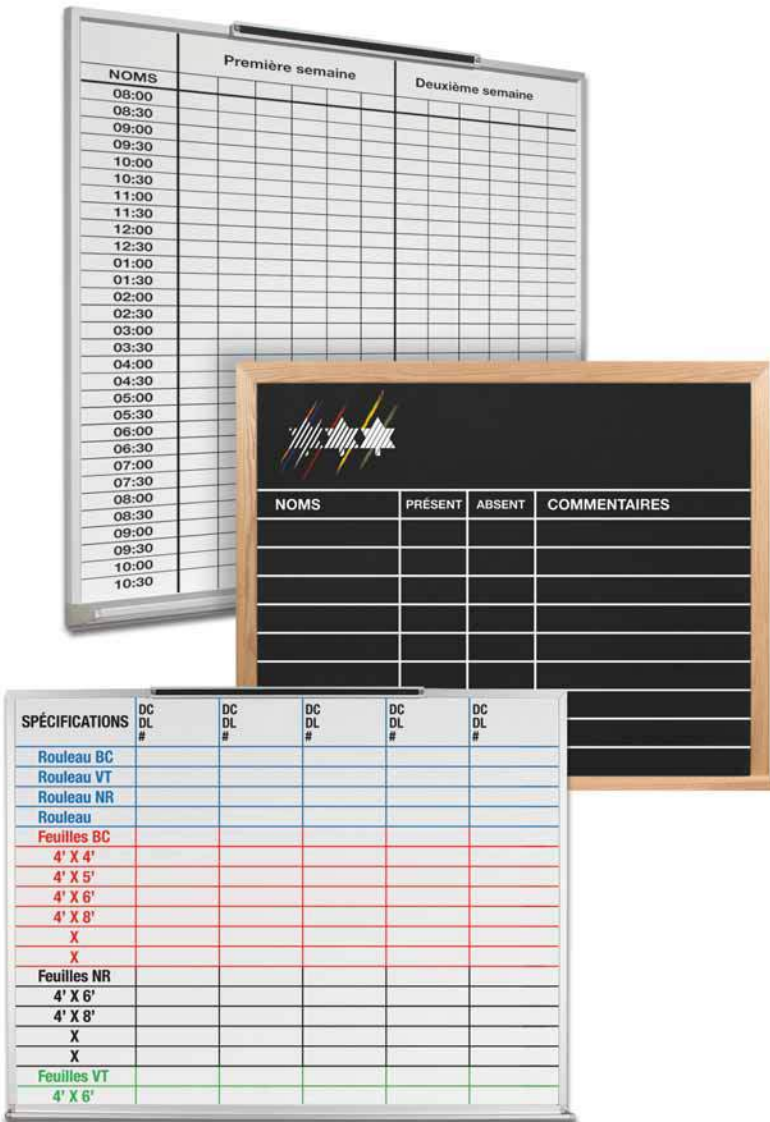

THE 720

For limited spaces, the fan board provides you with 8 or 12 writing or display surfaces. 4 or 6 panels pivot on a 180° vertical axis. Robust aluminum frame. Steel supports.



Sizes

- 3' X 2'
- 4' X 2'
- 3' X 3'
- 4' X 3'
- 4' X 4'





complements

projection screens
directional network
accessories
mouldings

series

complements

ROLLERAMIC

Heavy duty electric projection screen. It is designed for wall or ceiling mounting. The projection surface is available as vinyl matt white surface on woven fibreglass. Ask for our complete Draper catalogue.

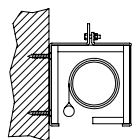
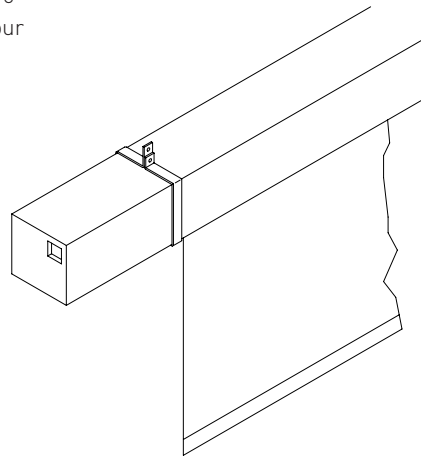

Wall mounting

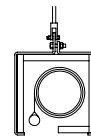

Ceiling mounting

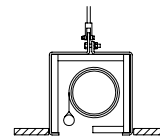

Flush mounting

LUMA

LUMA is Draper's most sophisticated spring-roller projection screen. The pentagonal case and end caps are in white steel. The case is elegant, solid and reliable. The LUMA projection surface is made of matt white vinyl on woven glass fibre.

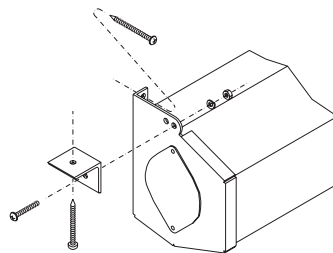

Wall mounting

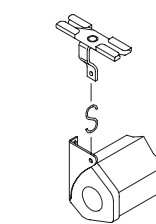

Suspended ceiling mounting

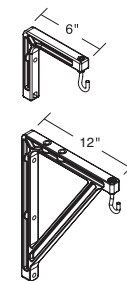

Wall bracket

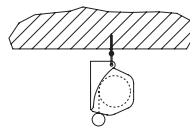
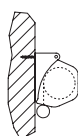

Ceiling mounting

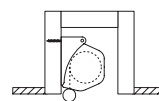

Flush mounting

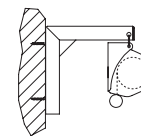

Map rail hook mounting

complements

GUIDANCE SYSTEM

We are proud to distribute Lawrence products. If you have crowd control needs (posts with retractable tape, fixed or portable posts with different metals or cords) do not hesitate to contact us to obtain a complete catalogue.

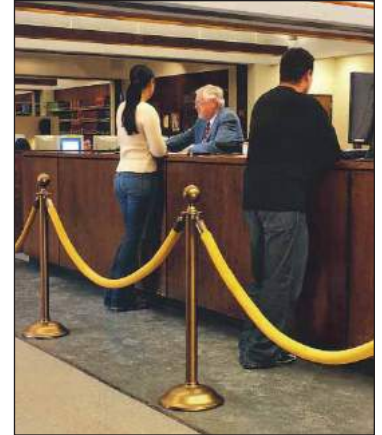

DISPLAY RAILS



100-AR



10R



20R

HOOKS



Hook 41



Hook 31



Hook 22

MAGNETIC

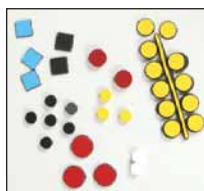

MAGNETIC TRAY



MAGNETIC STRIPS



MAGNETIC TAPES



CHALK



AEROSOL CHALKBOARD CLEANER



MARKERS



BRUSHES



complements

Series 2000

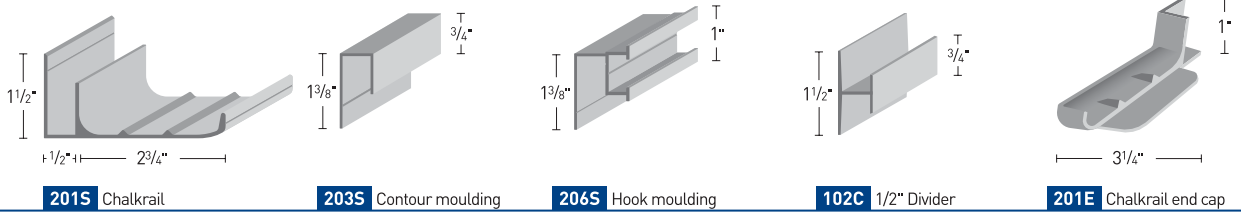

Series 3000

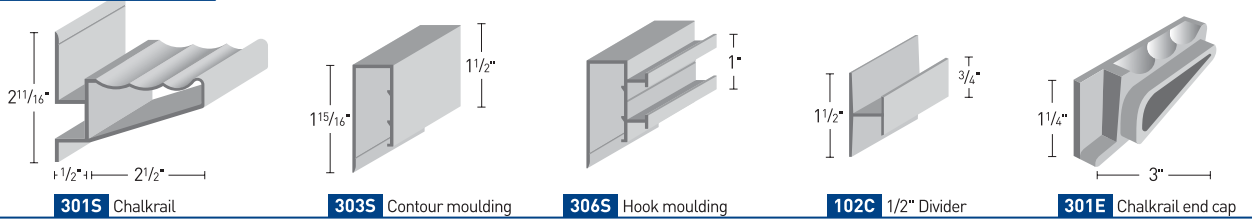

Series 5000

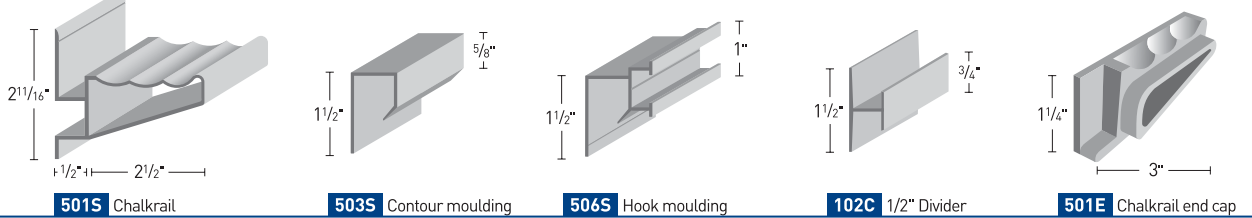

Series 8000

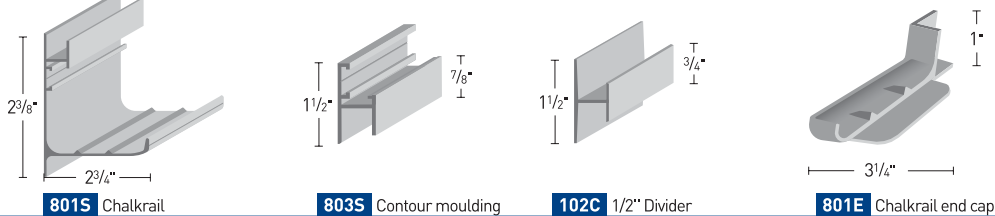

Series 950

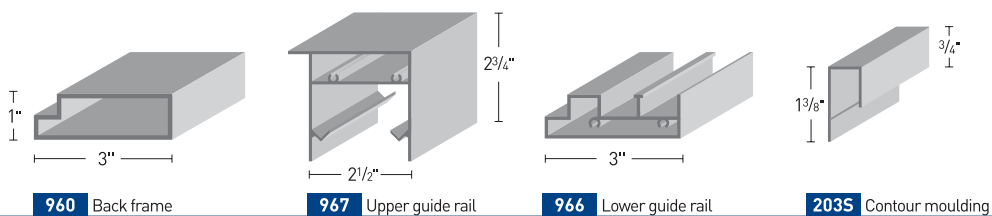

Series 900 / 910

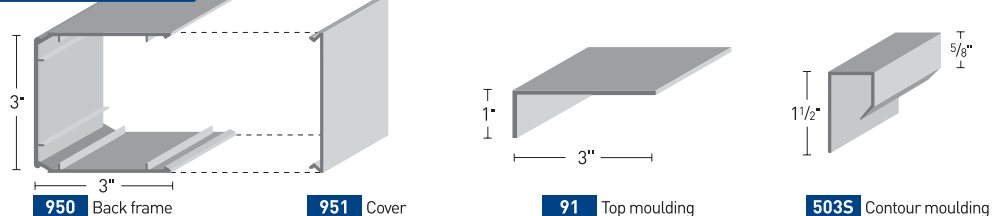

Series 80 / 85 / 90

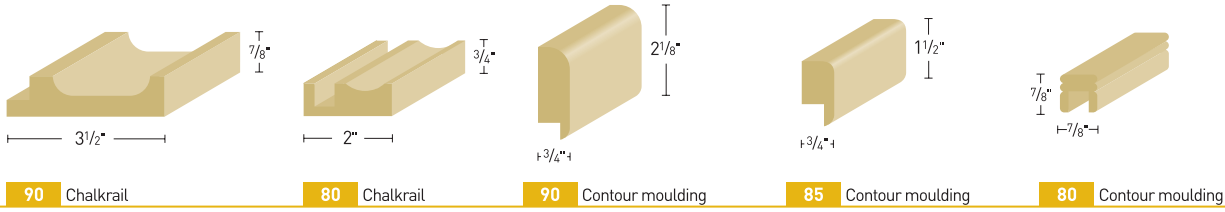

Series 640 / 670

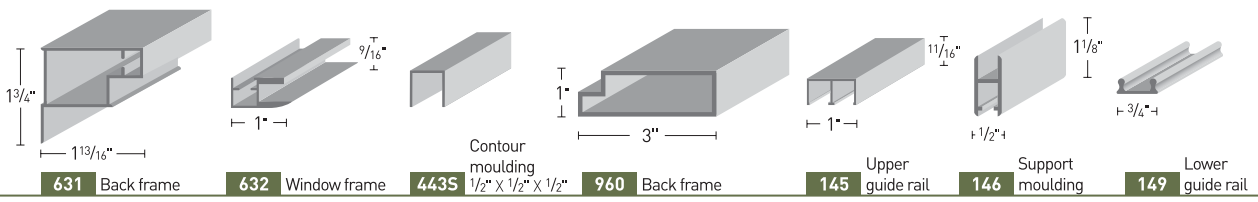

Series 40 / 70

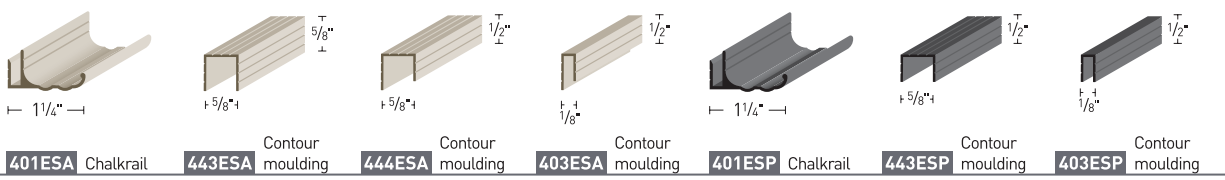

Fixation brackets

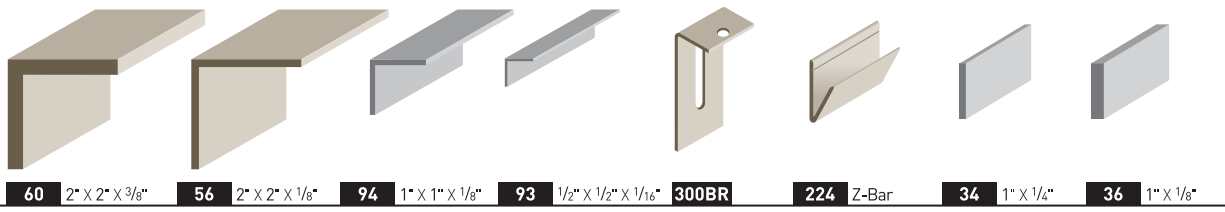



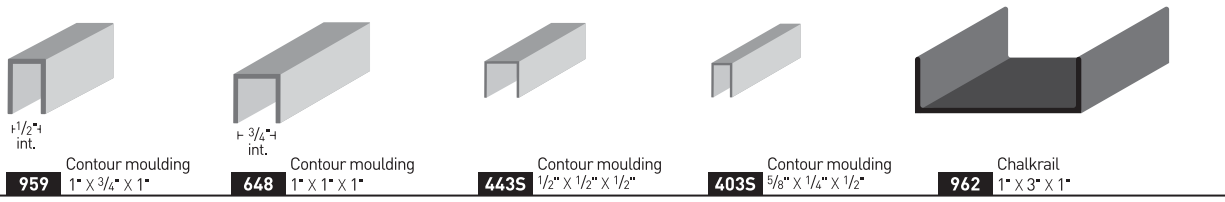

Miscellaneous

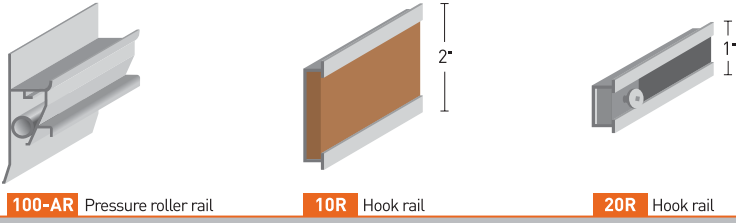

Display rails



Materials :

-  ANODIZED ALUMINUM
-  WOOD
-  PLASTIC
-  NATURAL ALUMINUM



Manufacturer
since 1932

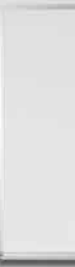
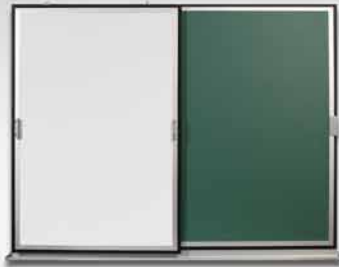

Canadian Blackboard Company Ltd
30, Montée des Bouleaux
St-Constant, Quebec J5A 1B6

Telephone: (450) 632-1660
Fax: (450) 632-5449

www.cctn.com